

PRODUCT FEATURES

MONODELTA is a single flap smoke vent suitable for the removal of large quantities of warm air and / or smoke from a building within a short period of time, daily ventilation and natural lighting. Suitable for utilization on shed style roofs.

The vents are manufactured according to ISO 9001 quality control standards and comply with the European requirements for NSHE according to EN 12101-2. Endurance tests with 10,000 opening and closing cycles have proven its robust and functional design. The vents are formed from high quality corrosion resistant aluminium to ensure low maintenance requirements and watertightness.

Various methods of operation using pneumatic or electric actuators are available. Available on large dimensions, up to 1250 x 3000 mm (width x length).

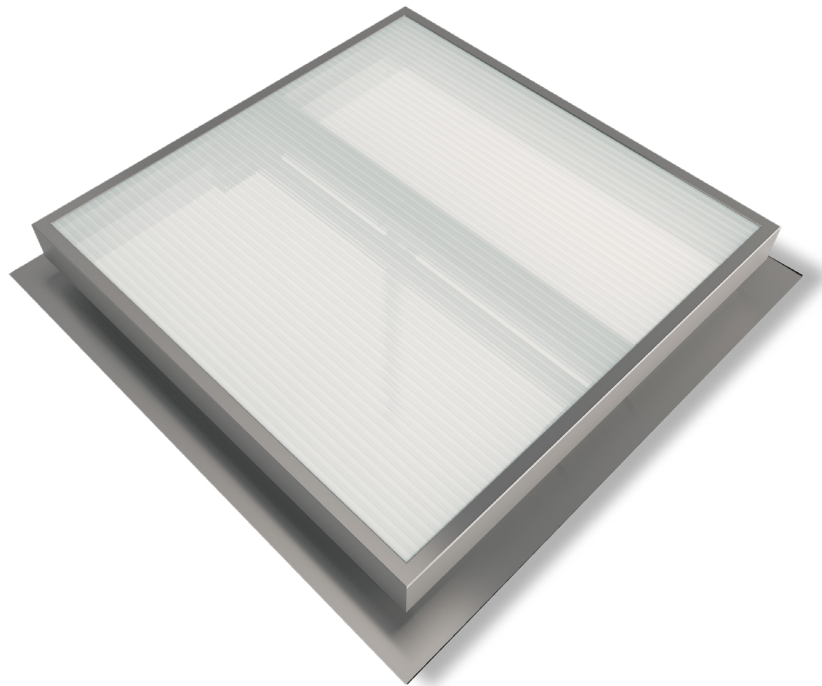

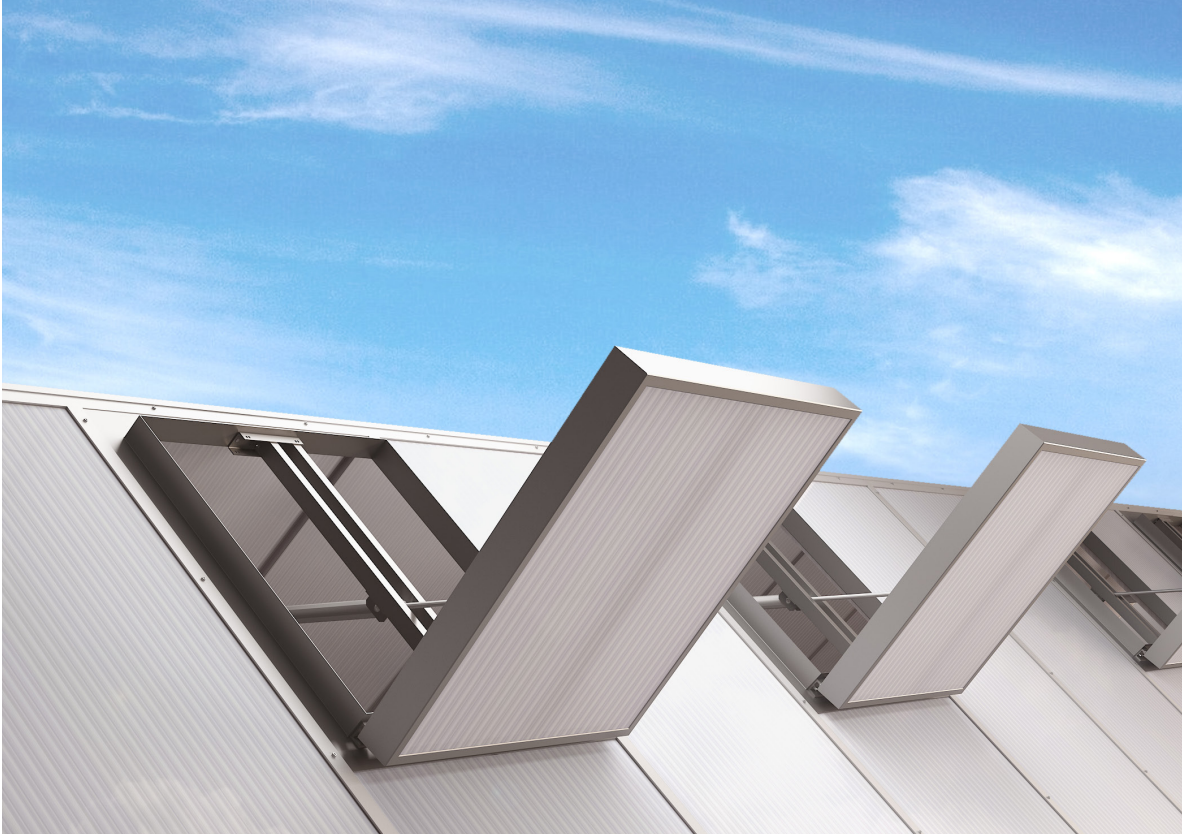

monodelta

TYPICAL APPLICATIONS

Shed style roofs: 15/15, 30/30, 45/45.

MATERIALS

Tempered aluminium, sea water and corrosion resistant (EN AW 5754).
Corrosion resistant bearings.
Sealant applied so that there is no freezing, enabling the equipment to have low air permeability at the same time.

Note: aluminum is supplied untreated as standard. Possibility of being supplied with electrostatic painting (in any RAL color).

DIMENSIONS

Roof opening width: 500 - 1250 mm.
Roof opening length: 500 - 3000 mm.

OPENING ANGLE

Open angle from 0° up to 85°.

CONTROLS NATURAL VENTILATION

P2: double pipe compressed air operation.
M230V: electric motor.

CONTROLS FIRE VENTILATION

P2F: double pipe compressed air operation with fire function.
M24V: electric motor.

FLAPS

- AL** Single aluminium.
- AL ISO** Double insulated aluminium (ISO thickness 20 and 50 mm).
- PC16** Polycarbonate 16 mm, clear or opal.
- PC25** Polycarbonate 25 mm, clear or opal.
- PC32** Polycarbonate 32 mm, clear or opal.
- TB** Thermal break in the aluminium profiles. Available for flaps of AL ISO, PC25 mm, PC32 mm.

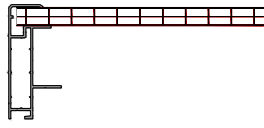

PC16

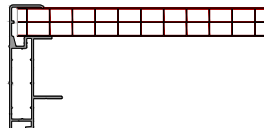

PC25

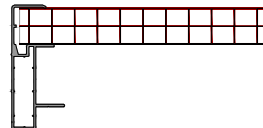

PC32

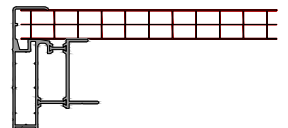

PC25 TB

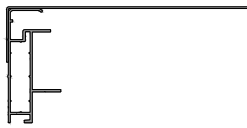

AL



AL ISO 20

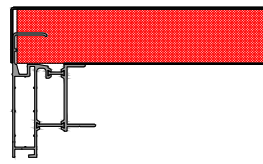

TB AL ISO 50

BASES

- Single aluminium.
- Double wall aluminium with insulation.
- Double wall aluminium with insulation and TB, thermal break in the aluminium base.

Note: other non-standard bases available upon request.

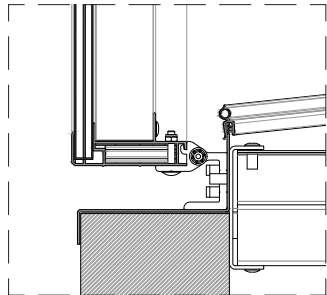

DETAIL 01
standard aluminium

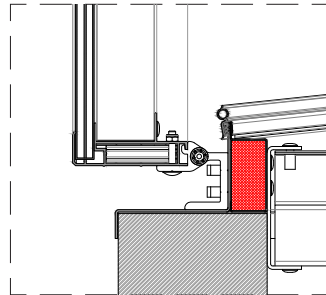

DETAIL 02
insulated aluminium

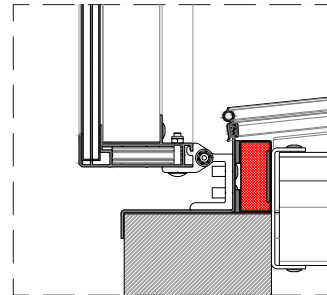

DETAIL 03
double insulated
aluminium and TB

FLANGES

- S1** Flange for single glass.
- S2** Flange for double glass.
- S3** Flange for roofs, 45° bended.
- S4** Flange for roofs and facades.
- S5** Flange for upstand, 90° bended downwards.
- S6** Flange 90° bended upwards
- SLS** Flange for skylight connection, for different polycarbonate thicknesses.
- SC** Flange for connection with other flange (vents connection). Male or female connection.
- SCM** Flange for male connection.
- SCF** Flange for female connection.

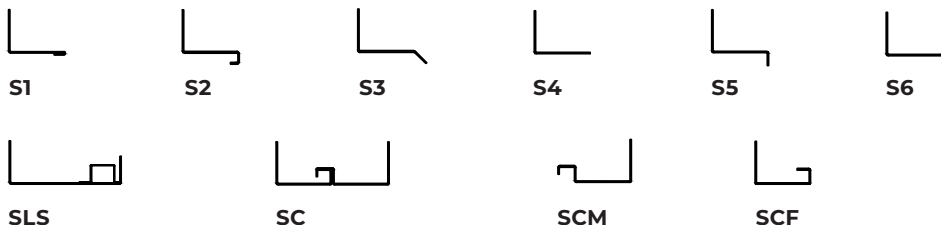

WEIGHT

Depends on dimensions and type of infill.

OPTIONS

Custom dimensions.
 Powder-coated design (any RAL colour).
 Bird or insect mesh.
 Anti-fall grid 1200 J.

REGULATIONS

The system has been tested and is certified in accordance with EN 12101-2
 Tested in accordance with the Directive 2014/34/EU, DELTA is ATEX certified equipment.

DIMENSIONS

WIDTH	500 up to 850	851 up to 1250
STROKE	575 mm	800 mm
PNEUMATIC CYLINDER	PVZ 40-00	PVZ 40-00
	-	PVZ 50-00
ELECTRIC MOTOR 2A	JM - DC3 900N	JM - DC3 900N
ELECTRIC MOTOR 4A	JM - DC3 1600N	JM - DC3 1600N

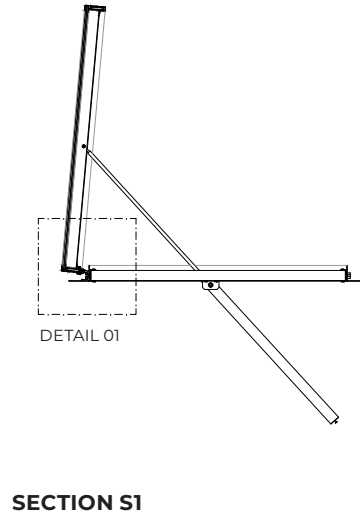
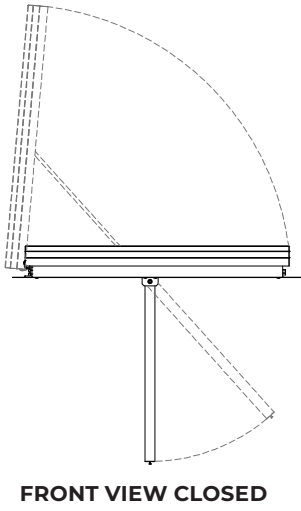
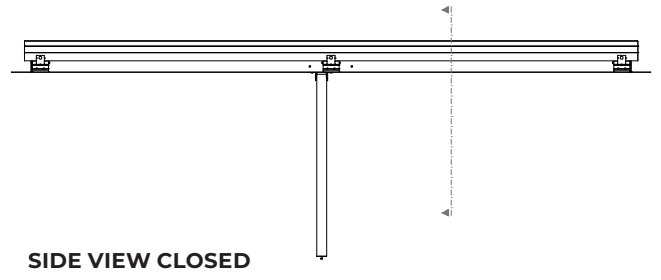
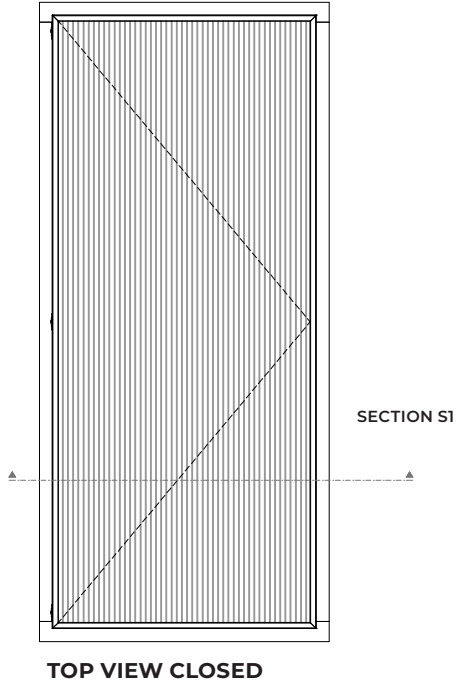

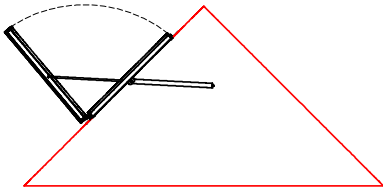

SECTION S2

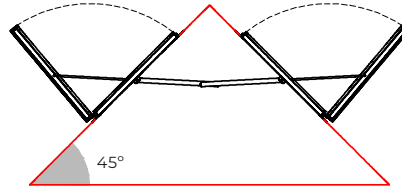

SECTION S3

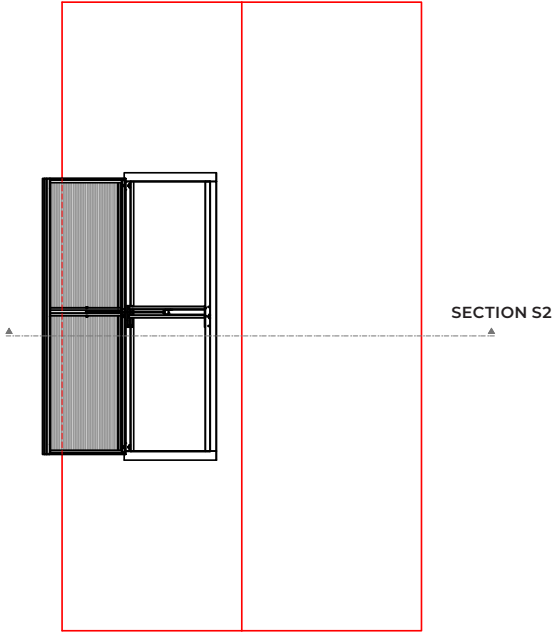

TOP VIEW

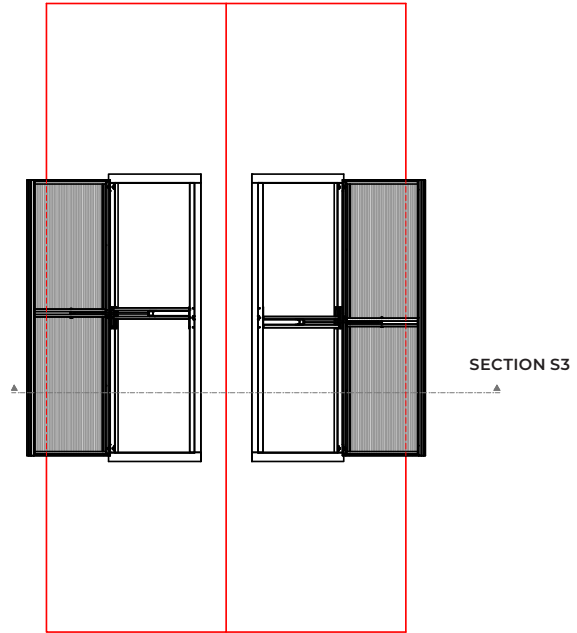

TOP VIEW

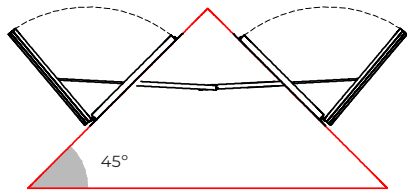

SECTION S4

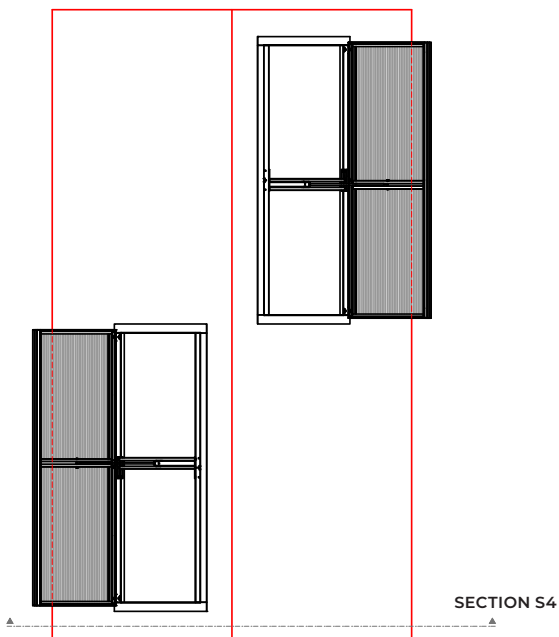

TOP VIEW